

Torishima Pump Global Network



East Asia

- 1 Torishima Pump Mfg. Co., Ltd. ■ ■
1-1-8 Miyata-cho, Takatsuki-city, Osaka 569-8660 Japan
Tel : +81-72-690-2308 / Fax : +81-72-690-2329
- 2 Kyushu Torishima Co., Ltd. ■
9857-13, Ohaza Kawako, Wakagi-cho, Takeo-city, Saga 840-0813 Japan
Tel : +81-954-26-3081 / Fax : +81-954-26-3080
- 3 Torishima Pump Mfg. Co., Ltd. Beijing Office
Rm707, Building 1, KUNSHA CENTER, No.16 Xinyuanli, Chaoyang District, Beijing, P.R.China PC:100027
Tel : +86-10-84682891 / Fax : +86-10-84682890
- 4 Torishima Pump (Tianjin) Co., Ltd. ■
No.9 Gaoxin Road, Wuqing Development Zone, Tianjin, P.R.China PC:301700
Tel : +86-22-59695601 / Fax : +86-22-59695609
- 5 Torishima (Hong Kong) Ltd. ■ ■
Unit A, 21/F., Tower A, Billion Centre, 1 Wang Kwong Road, Kowloon Bay, Kowloon, Hong Kong
Tel : +852-2795-1838 / Fax : +852-2754-3293

South East Asia

- 6 Torishima (Hong Kong) Ltd. Vietnam Office
No.76 Bui Thi Xuan Street, Hai Ba Trung District, Hanoi, Socialist Republic of Vietnam
Tel : +84-4-943-7880 / Fax : +84-4-943-7876
- 7 Torishima Pump Mfg. Co., Ltd. Singapore Office
82 Toh Guan Road East, #C2-14-4 WaterHub, Singapore 608576
Tel : +65-6779-0123 / Fax : +65-6779-6900
- 8 Torishima Service Solutions Asia Pte. Ltd. ■
48, Toh Guan Road East, #02-142, Enterprise Hub, Singapore 608586
Tel : +65-6933-8772 / Fax : +65-6933-8777

- 9 P.T. Torishima Guna Engineering ■
10 P.T. Torishima Guna Indonesia ■
Jalan Rawa Sumur Timur No.1 Pulogadung Industrial Estate, P.O.Box 1160, Jakarta, Indonesia
Tel : +62-21-460-3963 / Fax : +62-21-460-3937
- 11 P.T. Geteka Founindo ■
JL Pulo Ayang Kav. AA2 Pulogadung Industrial Estate, P.O.Box 1160 JAT, Jakarta 13011 Indonesia
Tel : +62-21-460-3963 / Fax : +62-21-460-3937

South Asia

- 12 Torishima Pumps India Pvt. Ltd.
302 & 302A, 3rd Floor, Tower-B, Millennium Tower, Sector27, Gurgaon-122002, Haryana, India
Tel : +91-124-4728950 / Fax : +91-124-4728950
- 13 Torishima Pumps India Pvt. Ltd. Service Division ■
Plot No. 27 B, C, D, Hoskote KIADB Industrial Area, Chokkahalli Village, Kasaba Hobli, Hoskote Taluk, Bangalore-562114, Karnataka, India
Tel : +91-80-39581000 / Fax : +91-80-39581010

Oceania

- 14 Torishima Australia Pty. Ltd.
643-645 Glenhuntly Road, Caulfield South VIC 3162 Australia
Tel : +61-3-9523-7998

Middle East

- 15 Torishima Service Solutions FZCO ■
Plot of Land TP010501 Techno Park-Jebel Ali, PO Box. 37603 Dubai, U.A.E.
Tel : +971-4-880-7344 / Fax : +971-4-880-7354
- 16 Torishima Pump Mfg. Co., Ltd. Middle East Office
Office No.901, Deluxe Tower, Delma Street, Al Nahyan Camp Area, P.O.Box 53567, Abu Dhabi, U.A.E.
Tel : +971-2-674-3880 / Fax : +971-2-674-3881
- 17 Torishima Pump Mfg. Co., Ltd. Qatar Project Office
Office No.11,1st Floor, West Corner Centre, Salwa Road-Midmac R/A, P.O.Box 37027 Doha, Qatar
Tel : +974-4450-6915 / Fax : +974-4450-6916

- 18 Torishima Pump Mfg.Co.,Ltd. Saudi Arabia Office
Al Riyadh, Al Khair Plaza, Office No.2 Al Amir Muhd IBN A.A. Road, Althalea SP-643351929, Kingdom of Saudi Arabia
Tel : +966-11-2931366

Europe

- 19 Torishima Europe Ltd.
2 Colliery Gate, Clyde Gateway East, Glasgow G32 8RH Scotland, UK
Tel : +44-1236-443951 / Fax : +44-1236-702875
- 20 Torishima Service Solutions Europe Ltd. ■
2 Colliery Gate, Clyde Gateway East, Glasgow G32 8RH Scotland, UK
Tel : +44-1236-442390 / Fax : +44-1236-702875
- 21 Torishima Europe Projects Ltd.
Torishima House, Brook Lane, Westbury, Wiltshire BA13 4ES England, UK
Tel : +44-1373-858143
- 22 Torishima Europe Ltd. Madrid Office
Avda, Fuente Nueva 12, 28703 San Sebastian de los Reyes, Madrid, Spain
Tel : +34-91-002-7541 / Fax : +34-91-284-6901
- 23 Torishima Europe Ltd. Poland Office
ul. Pomianowska 7, 03-136 Warszawa, Poland
Tel : +48-604-557-137

North America

- 24 Torishima Pump Mfg. Co., Ltd. North America East Office
100 Grove Street, Suite 217, Worcester MA 01605-2654 U.S.A.
Tel : +1-508-753-6600 / Fax : +1-508-753-8276

Central America

- 25 Torishima Europe Ltd. Mexico Office
Av Paseo de La Reforma 350,11th floor, Juárez,Cuauhtémoc, 06600 Ciudad de México,D.F., México
Tel : +52-55-9171-1426 / Fax : +52-55-9171-1499

CAL (Cast Iron)

CAR (Stainless Steel)

End-Suction Volute Pump



CAL



CAR

Go Green with The Eco-Pumps



CAL: Cast Iron
CAR: Stainless Steel
(10bar)

Energy Saving	<ul style="list-style-type: none"> High-Efficiency Pump Impeller Trimmed to Exactly Meet Customer Specification Ultra High Efficiency Motor (Equivalent to IEC IE3)
Downsizing	<ul style="list-style-type: none"> Higher Speed Enables Same Duty to be Achieved with Smaller Pump
Easy Maintenance	<ul style="list-style-type: none"> Simple Maintenance with Mechanical Seals Excellent Parts Interchangeability Back Pull-Out Design
Convenience	<ul style="list-style-type: none"> Low NPSH (High Suction Performance) Stable Operation
Safety	<ul style="list-style-type: none"> Shaft Guard and Totally Enclosed Coupling Guard

Optimized Hydraulic Performance

CFD (Computational Fluid Dynamics) optimized casing design ensures smooth fluid flow.

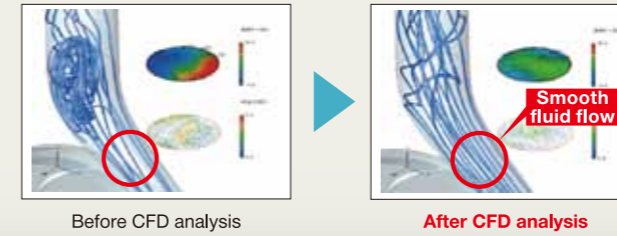

3D High-Efficiency Impeller

Three dimensional curved impeller optimizes smooth fluid flow.

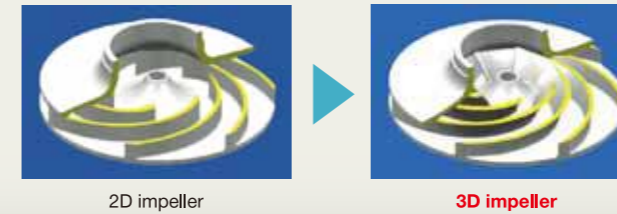

Meeting Customer's Specification (Impeller cut)

The impeller diameter can be cut to meet the customer's specification to reduce unnecessary power consumption.

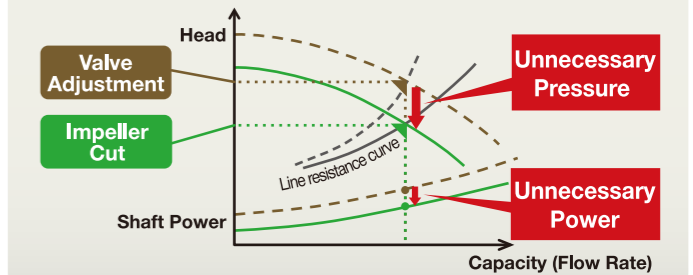
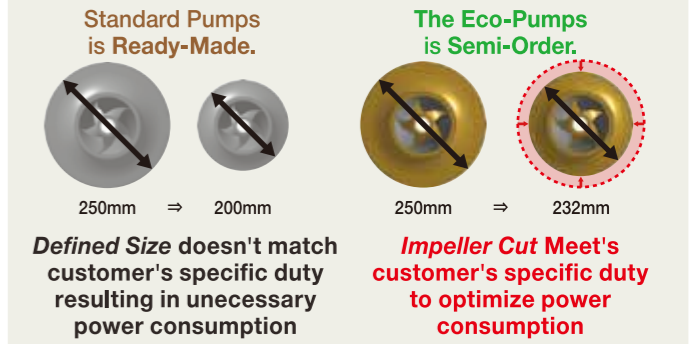

TU Motor (Torishima Ultra High Efficiency Motor)

IEC (International Electrical Commission) classifies IE1 (standard), IE2 (high efficiency), IE3 (premium efficiency) by motor efficiency. TU motor is equivalent to IE3.

- Iron losses are reduced by use of high quality magnetic steel sheet.
- Copper losses are reduced by coil combination and optimized iron core configuration.
- Mechanical losses are reduced by downsized fan.
- Reduced noise

Motors of the following power output are in regular stock.
2P: 0.75kW to 22kW
4P: 0.75kW to 55kW

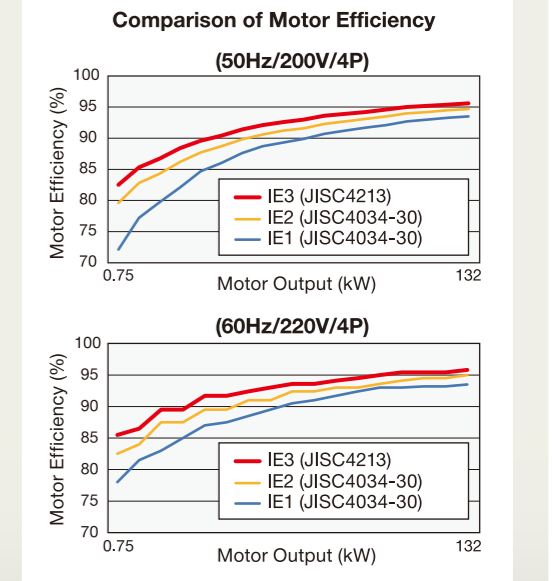

Mechanical Seal as Standard

Standard mechanical seal (rubber bellows type) is easy to install and does not damage shaft, thus eliminating need for shaft sleeve. Minimal leakage from seal improves cleanliness around pump.

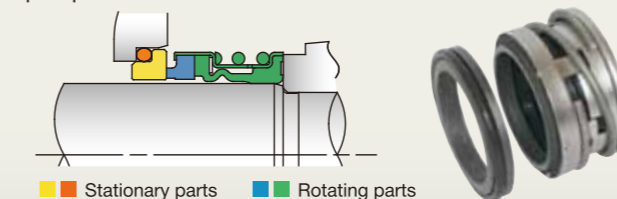

Low NPSH / Stable Operation

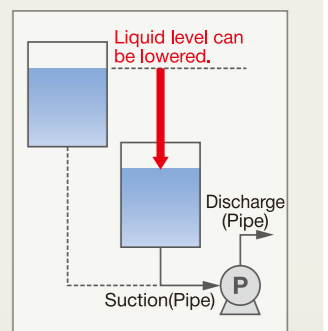

Enhanced Safety with Shaft Guard and Totally Enclosed Coupling Guard

The Eco-Pumps (CAL/CAR) are equipped with a shaft guard and totally enclosed coupling guard. A totally enclosed coupling guard improves safety and maintenance compared to an existing coupling guard due to the wide area of coverage.

Existing Pump with Standard Coupling Guard and No Shaft Guard



Totally Enclosed Coupling Guard and Shaft Guard



Shaft Guard



Totally Enclosed Coupling Guard

All CAL/CAR series pumps are equipped with shaft guard.

Applied condition of enclosed coupling guards:
TU motor: 2P-55kW or less, 4P-110kW or less
Coupling diameter: 280mm or less
Motor size and frame depends on manufacturer selected.

Higher Speed Enables Pump Size to be Reduced

Increasing the pump speed by using a 2 pole motor reduces the pump size and weight.

Conditions: total head of 50m, capacity of 1m³/min, 60Hz

Pole number: 4P
Pump size: CAL80-400
Motor output: 18.5kW
Weight: **400kg**

Pole number: 2P
Pump size: CAL50-200
Motor output: 15kW
Weight: **209kg**

Weight reduced by 47% compared to 4P!

$$= (400 - 209) \div 400 \times 100$$

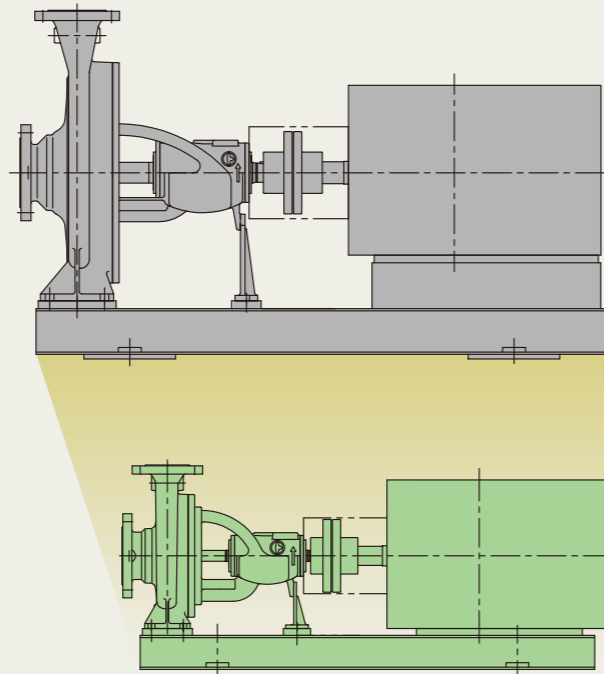



The above diagram describes characteristics of 2P. We can provide the design for 4P as well. Weight includes pump, base plate, motor and coupling. Motor weight differs depending on manufacturer.

Applications

Utility	Co-generation	Cooling water pump, Hot water (circulation) pump
	Air conditioning	Cold water pump, Cooling water pump, Hot water pump
	Drainage treatment	Raw water pump, Filtrate pump, Back wash pump, Transfer pump
	Pure water facility	Raw water pump, RO wash pump, Recovering back wash pump, Filtrate water pump
Iron and Metal	Power generation	Deaerator feed water pump
	Hot rolling	Transfer pump, Hot water pump, Water pumping pump, Filtrate pump, Back wash pump,
	Flue gas desulfurization	Cooling water pump, Industrial water pump
	Roll coolant	Spray pump
	Plating	Wash pump (Rinse pump)
	Manufacturing process	Cold water pump, Cooling water pump (Circulation / Boost), Recycle water pump, Filtrate pump, Sprinkling pump
Food and Beverage	Refrigerator	Chilled pump, Defrost pump
	CIP system	CIP supply / return pump
	Degreasing process	Degreasing pump, Hot / Cold water wash pump, Spray pump
Automobile (Painting plant)	Transformation process	Chemical pump, Hot / Cold water wash pump, Pure water pump
	Electrodeposition process	Electrodeposition liquid circulation pump, Wash pump, Pure water pump
	Power generation	Deaerator feed water pump, Condensate pump,
Garbage incinerating plant	Heat decrease tower	Heat decrease pump, Spray pump for heat decrease tower
	Drainage	Reuse water pump (pumping, transferring, feeding)
	Other liquid handled	Brain, Acetone, Calcium chloride, Kalium chloride, Alkaline solution, Ethylene glycol, Agua fortis, Sulfate, Sodium hydroxide, Ammonia liquor, Caustic soda, etc. <i>Please ask about special fluid.</i>

Specification

		CAL (Cast Iron) 	CAR (Stainless Steel) 
Handled liquid	Kinds	Clean water, Warm water, Oil, Chemical medicine, Alkaline solution, Brine, Heat transfer media, Abrasive slurry liquid under 3wt%, etc.	Pure water, Hot water, Sea water, Salted water, Refrigerant, Electrodeposition paint, Abrasive slurry liquid under 3wt%, etc.
	Temperature	Standard: -10°C to +80°C Option: -30°C to +350°C	Standard: -10°C to +80°C Option: -40°C to +140°C
Max. discharge pressure		Standard: 1MPa (10kgf/cm ² G) Option: 1.4MPa (14kgf/cm ² G)	1MPa (10kgf/cm ² G)
Max. suction pressure		0.8MPa (8kgf/cm ² G)	0.8MPa (8kgf/cm ² G)
Design	Impeller	Closed	Closed
	Shaft seals	Standard: Single mechanical seal (Rubber bellows) Option: Double mechanical seal, Gland packing	Standard: Single mechanical seal (Rubber bellows) Option: Double mechanical seal, Gland packing
	Water injection for bearing	Standard: Internal injection Option: Quenching, Flushing	Standard: Internal injection Option: Quenching, Flushing
	Lubricated bearing	Standard: Grease lubrication Option: Oil lubrication	Standard: Grease lubrication Option: Oil lubrication
Flange standard, Suction / Discharge direction		JIS 10K R.F. Shaft direction suction / Vertical top discharge	JIS 10K R.F. Shaft direction suction / Vertical top discharge
Pump material	Casing	Standard: FC250 Option: FCD400	Standard: SCS13 Option: SCS14
	Impeller	Standard: FC200 Option: SCS13	Standard: SCS13 Option: SCS14
	Shaft	Standard: SUS420J2 Option: SUS329J1+S45C, SUS304	Standard: SUS304 Option: SUS316, SUS329J1+S45C
	Case wear ring	Standard: PSG Option: SUS304	—

Design Features

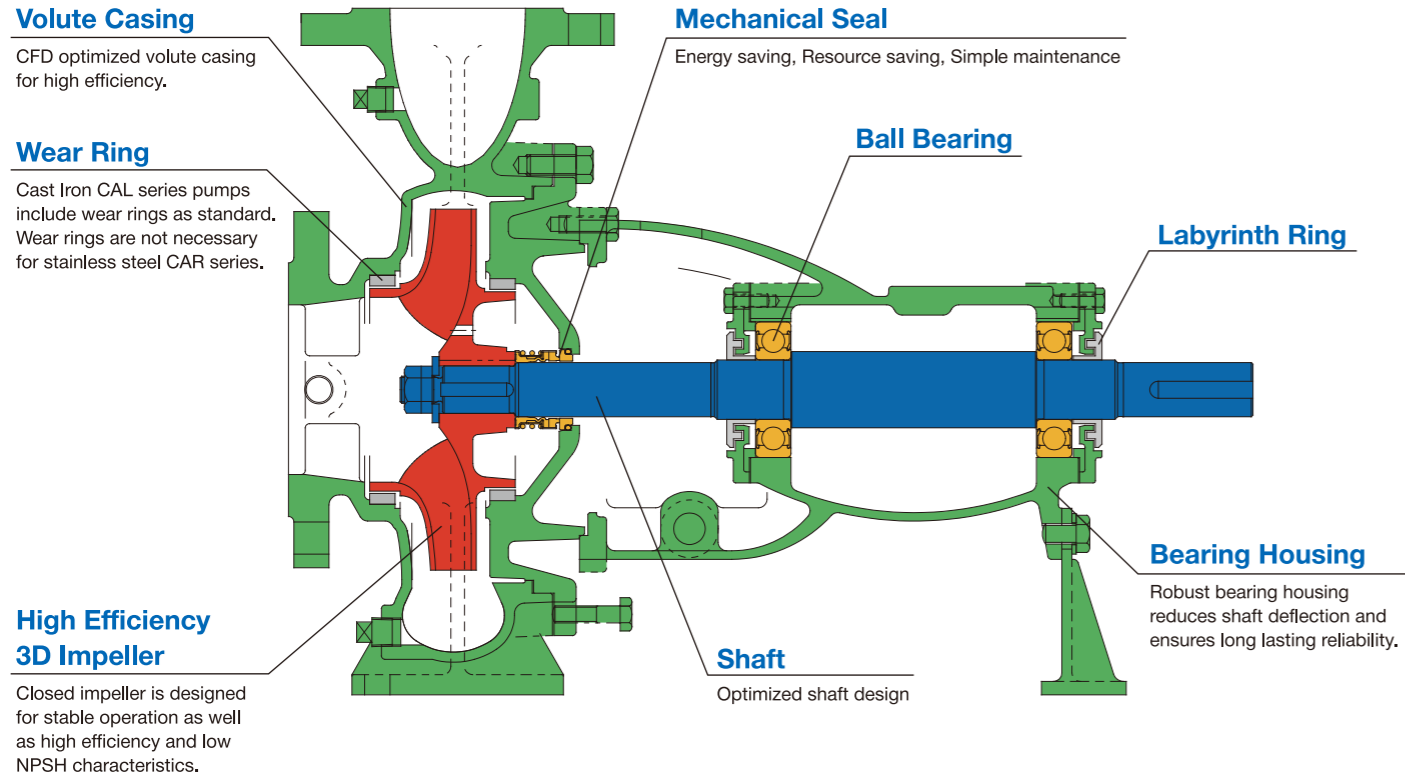

Pump Sectional Drawing

The basic structure is same between CAL and CAR for parts interchangeability. CAR, which is made from stainless, does not require case wear ring. Due to adopting build to order method, various combination with pump material, seal and bearing is available according to liquids kinds and temperature.

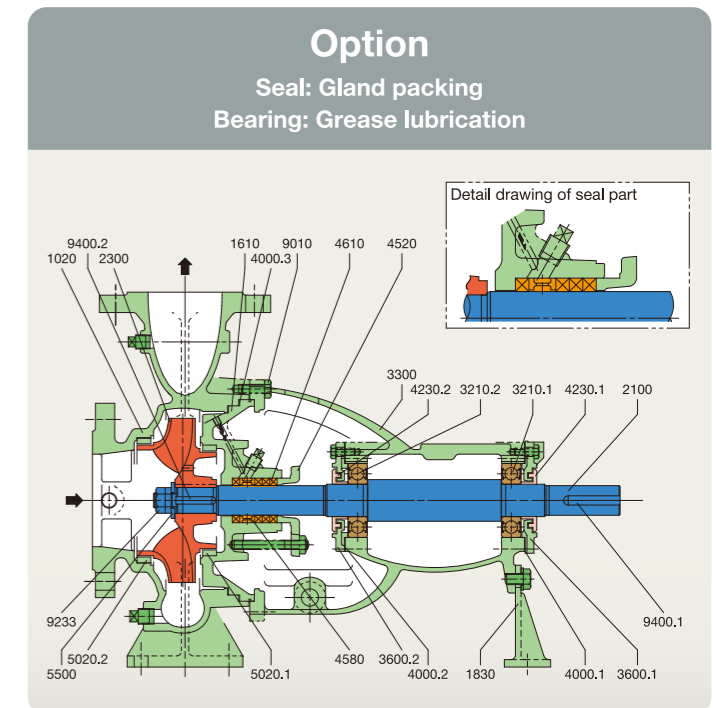
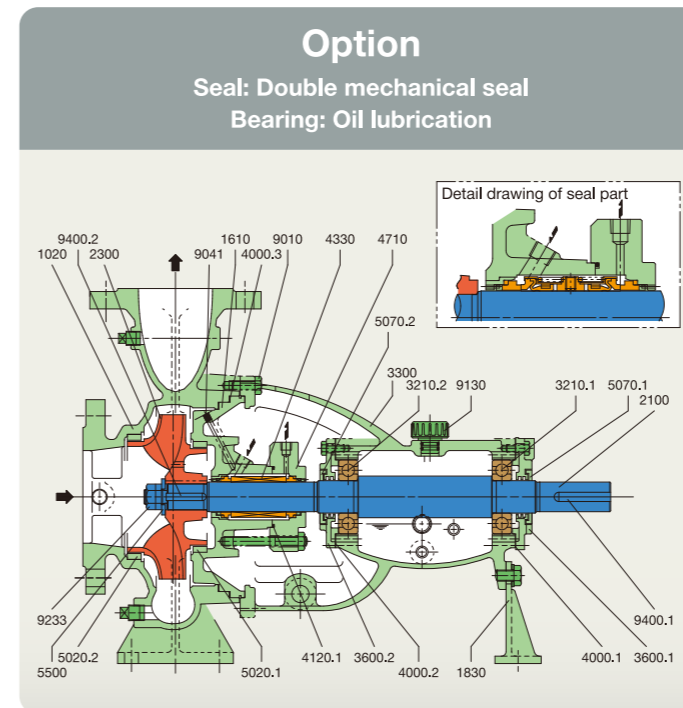
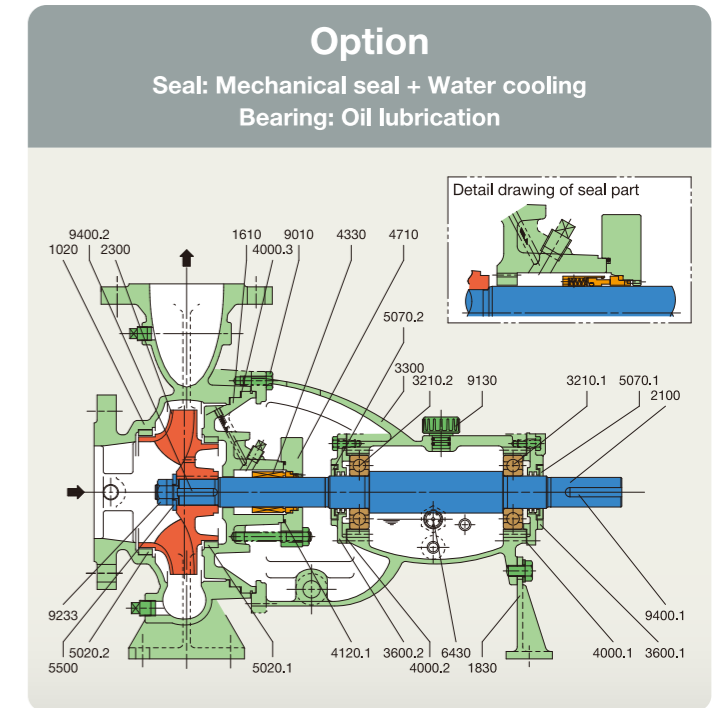
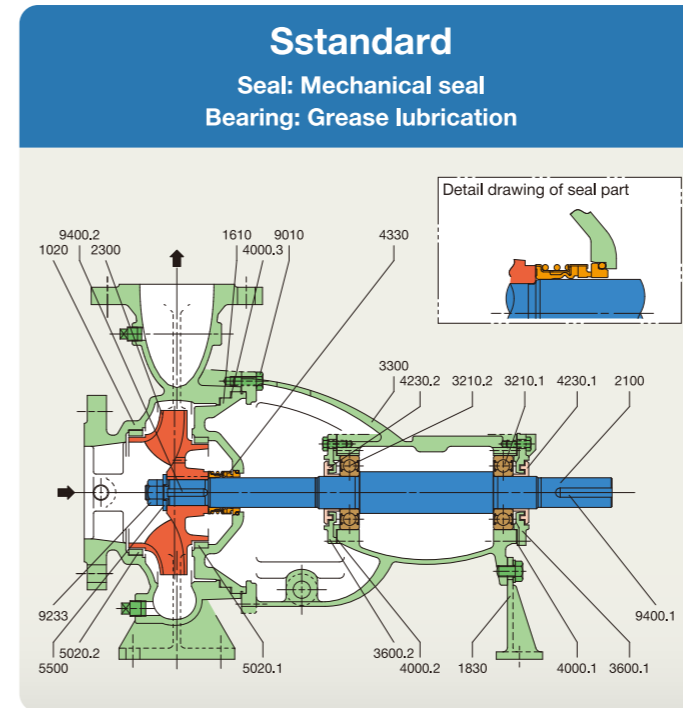

Parts Interchangeability

■ **2P type** Same color and number in the same parts indicate interchangeability.

Pump type	Casing	Casing Cover	Bearing Housing	Shaft	Mechanical Seal
32-125	1				
40-125	2	1			
65-125	3				
32-160	4				
40-160	5	2	1	1	1
50-160	6				
32-200	7				
40-200	8	3			
50-200	9				
80-160	10	4	2	2	
80-200	11	5			
32-250	12				2
40-250	13	6	3	3	
50-250	14				
80-250	15	7			

■ **4P type** Same color and number in the same parts indicate interchangeability.

Pump type	Casing	Casing Cover	Bearing Housing	Shaft	Mechanical Seal
32-125	1				
40-125	2	1			
65-125	3				
32-160	4				
40-160	5	2	1	1	1
50-160	6				
65-150	7				
32-200	8				
40-200	9	3			
50-200	10				
65-190	11				
80-150	12	4			
80-190	13				
100-190	14	5			
32-250	15				
40-250	16	6			
50-250	17				
65-240	18				
80-240	19	7	2	2	2
100-245	20				
100-250	21				
50-315	22				
65-310	23	8			
80-310	24				
100-310	25				
150-190	26	9			
150-200	27		3	3	
125-240	28	10			
125-250	29				
200-240	30	11	4	4	3
200-250	31				
125-310	32	12			
125-315	33				
80-400	34	13	3	3	
100-400	35	14	4	4	
125-400	36				
150-310	37	15			
150-315	38				
150-390	39	16	5	5	4
150-400	40				

Parts number	Parts name	Parts number	Parts name	Parts number	Parts name	Parts number	Parts name
1020	Volute casing	3600.2	Bearing cover	4580	Lantern ring	9010	Hex. bolt
1610	Casing cover	4000.1	Flat gasket	4610	Gland packing	9041	Nock
1830	Support foot	4000.2	Flat gasket	4710	Seal cover	9130	Plug
2100	Shaft	4000.3	Flat gasket	5020.1	Casing wear ring	9233	Lock nut
2300	Impeller	4120.1	O-ring	5020.2	Casing wear ring	9400.1	Key
3210.1	Deep groove ball bearing	4230.1	Labyrinth ring	5070.1	Deflector	9400.2	Key
3210.2	Deep groove ball bearing	4230.2	Mechanical seal	5070.2	Deflector		
3300	Bearing housing	4330	Shaft box gland	5500	Washer		
3600.1	Bearing cover	4520		6430	Oil gauge		

CAL (Cast Iron) Selection Range Charts

**50Hz-2P
(3000min⁻¹)**

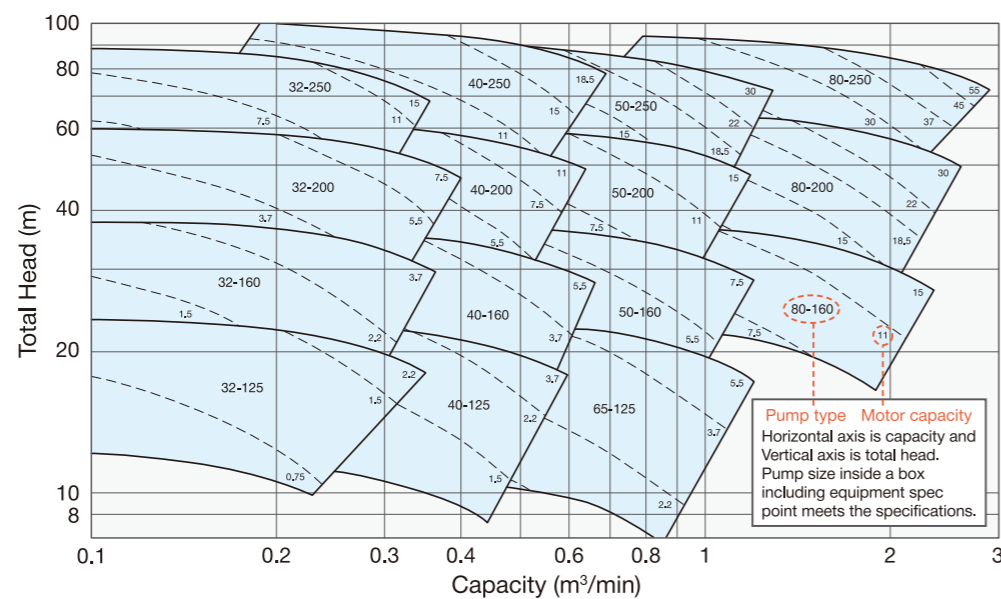

**60Hz-2P
(3600min⁻¹)**

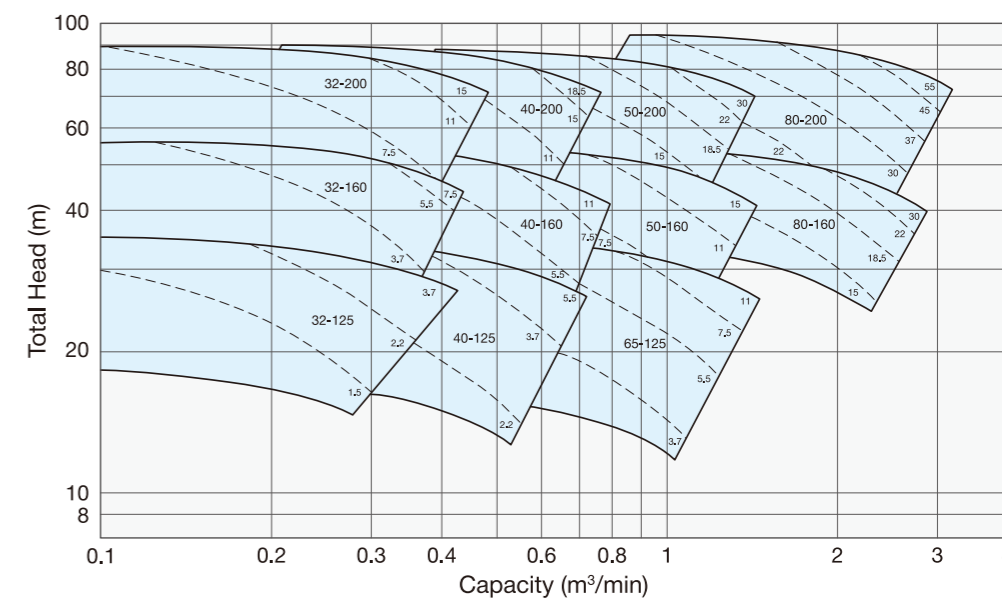

**50Hz-4P
(1500min⁻¹)**

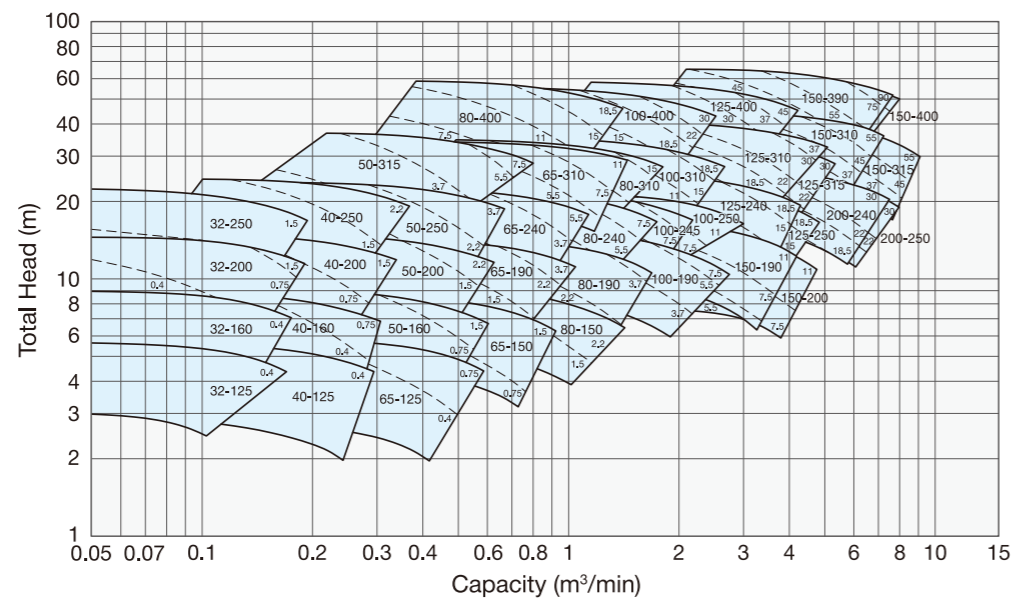

**60Hz-4P
(1800min⁻¹)**

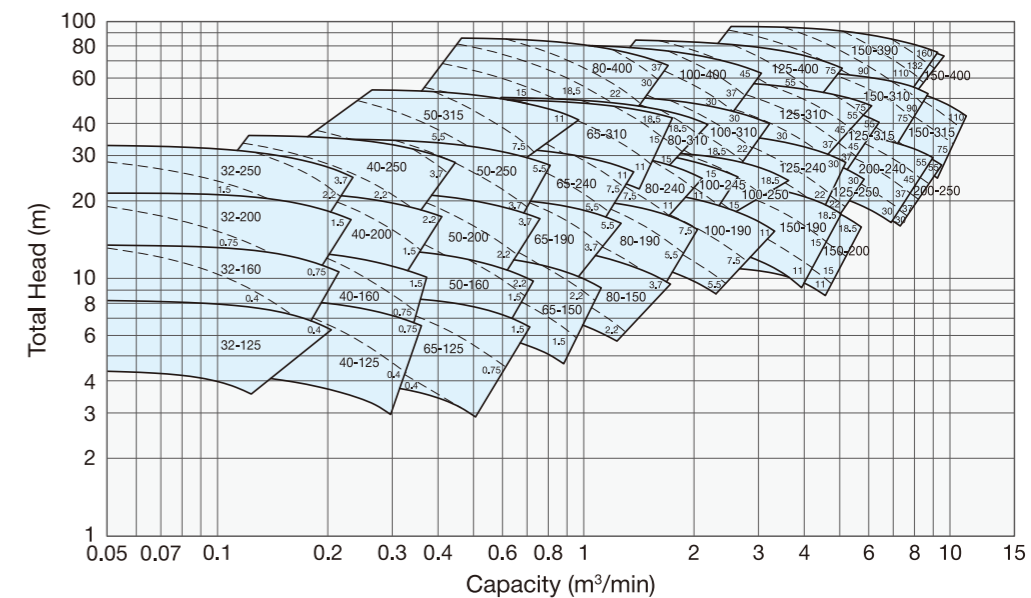

**50Hz-6P
(1000min⁻¹)**

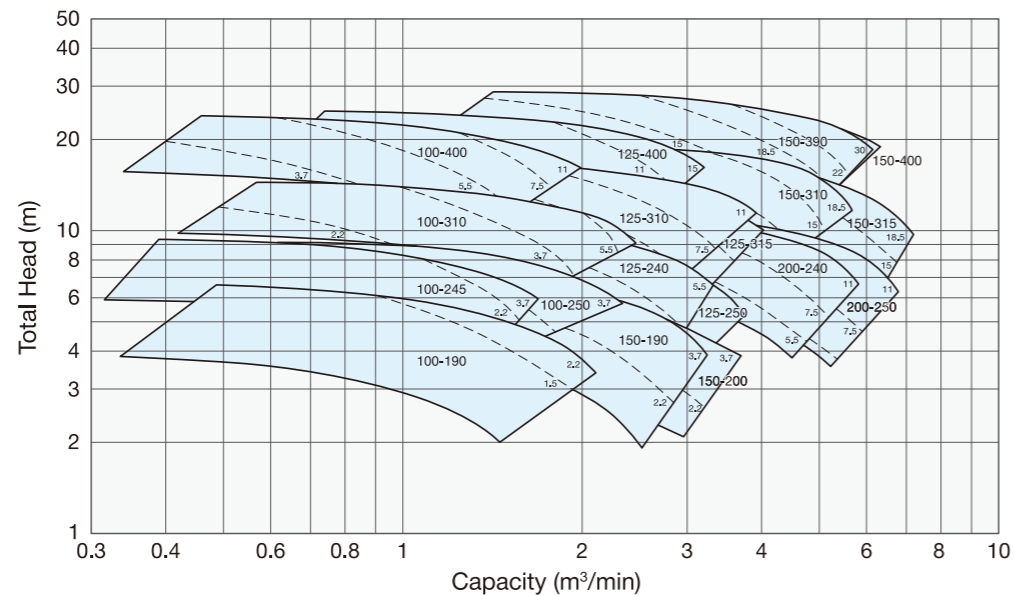

**60Hz-6P
(1200min⁻¹)**

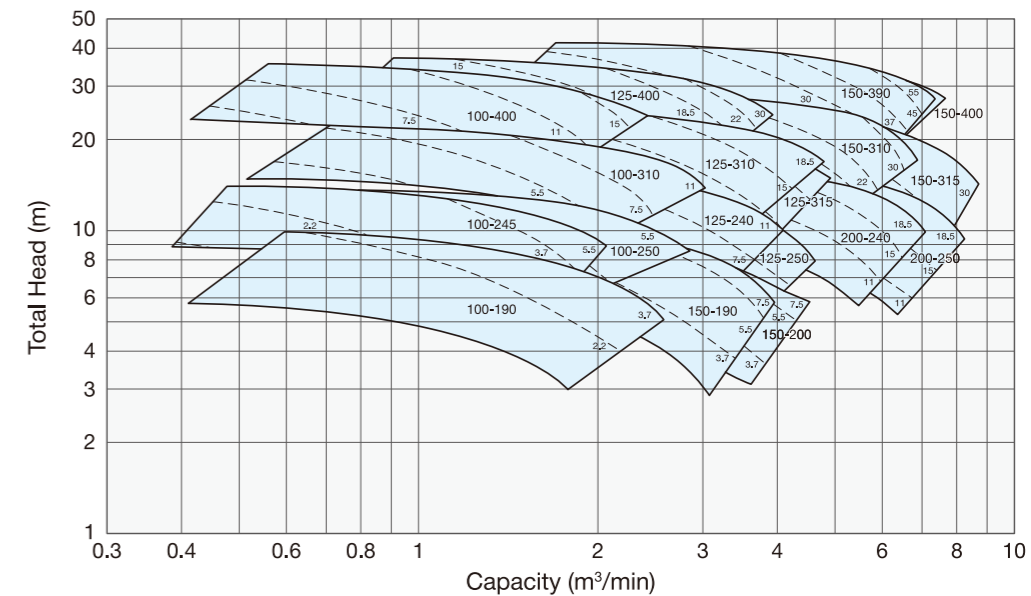

Dimension Table

- Flange standard CAL: JIS10K RF / CAR: JIS10K RF
- Dimension in the table is based on totally enclosed fan-cooled motor.
Note: Motor size and frame depends on manufacturer selected.
- */** in the table indicate that motor frame is the same but shaft diameter (d2) is different.
- Base plate material FC: Cast Iron SS: Steel
Option: FC (Cast Iron) can be replaced with SS (Steel).



FC Base Plate



SS Base Plate

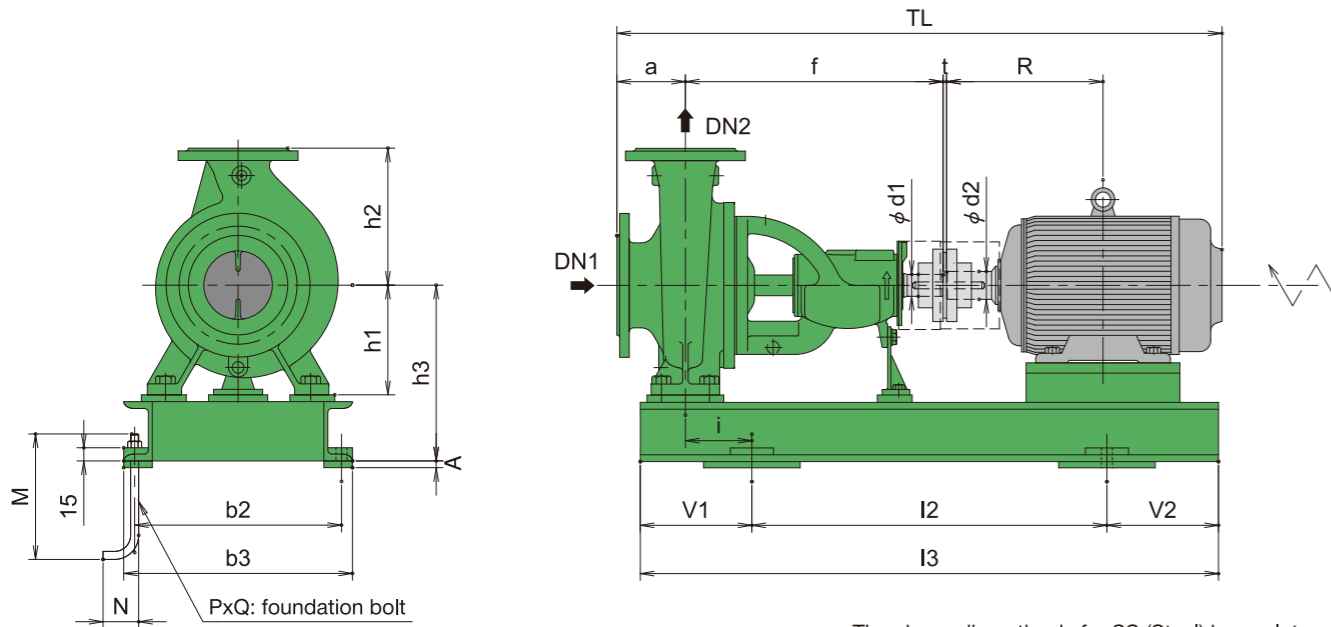

The above dimension is for SS (Steel) base plate.
FC (Cast Iron) base plate follows above.

Dimension Table for 2P Motor Drive

Pump Sizes	Pump							Motor			Base Plate				Foundation Dimensions								Coupling		Refer.						
	Bore		Dimension				Axle	Weight		Frame	Dimension		Material	b3	I3	A	Wt.	h3	i	b2	I2	M	N	P		Q	V1	V2	t	Wt.	TL
	DN1	DN2	a	f	h1	h2	d1	Grade	Grade		R	d2																			
	mm	mm	mm	mm	mm	mm	mm	kg	kg	mm	mm	mm	mm	mm	mm	mm	mm	mm	mm	mm	mm	mm	mm	mm		mm	mm	mm	mm	mm	
32-125 40-125	50 65	32 40	80 80	360 360	112 112	140 140	24 24	27 28	28 29	71M	120	14	FC	370	740	0	19.2	157	30	330	550	200	50	4	M12	95	95	3	1.1	681	
										80	140	19	FC	370	740	0	18.9	157	30	330	550	200	50	4	M12	95	95	3	1.1	725.5	
										80M	140	19	FC	370	740	0	18.9	157	30	330	550	200	50	4	M12	95	95	3	1.1	705	
										90S	156	24	FC	370	740	0	18.1	157	30	330	550	200	50	4	M12	95	95	3	1.1	750.5	
										90L	168.5	24	FC	370	740	0	18.1	157	30	330	550	200	50	4	M12	95	95	3	1.1	775.5	
										100L	193	28	FC	370	740	0	18.5	157	30	330	550	200	50	4	M12	95	95	3	1.6	809	
										112M	200	28	FC	370	740	0	15.7	157	30	330	550	200	50	4	M12	95	95	3	1.6	834.5	
32-160 40-160 65-125	50 65 80	32 40 65	80 80 100	360 360 360	132 132 132	160 160 180	24 24 24	28 30 31	30 31 33	132S	239	38	FC	370	820	0	21.9	177	20	330	650	200	50	4	M12	85	85	3	3.2	897	
										80	140	19	FC	370	740	0	19.7	177	30	330	550	200	50	4	M12	95	95	3	1.1	745.5	
										80M	140	19	FC	370	740	0	19.7	177	30	330	550	200	50	4	M12	95	95	3	1.1	725	
										90S	156	24	FC	370	740	0	19	177	30	330	550	200	50	4	M12	95	95	3	1.1	770.5	
										90L	168.5	24	FC	370	740	0	19	177	30	330	550	200	50	4	M12	95	95	3	1.1	795.5	
										100L	193	28	FC	370	740	0	19.1	177	30	330	550	200	50	4	M12	95	95	3	1.6	829	
										112M	200	28	FC	370	740	0	18.7	177	30	330	550	200	50	4	M12	95	95	3	1.6	854.5	
80-160	100	80	125	470	160	225	32	50	52	132S	239	38	FC	930	1000	0	33.9	225	0	480	740	200	50	4	M12	95	95	3	3.2	1052	
										160M	323	42	SS	470	1120	0	45	270	115	440	740	200	50	4	M12	190	190	3	5.4	1206	
										160L*	345	42	SS	470	1120	0	45	270	115	440	740	200	50	4	M12	190	190	3	6.7	1250	
										160L**	345	48	SS	430	1120	0	45	270	115	440	740	200	50	4	M12	190	190	3	9.0	1168.5	
										180MA	351.5	48	SS	470	1180	0	45	270	115	440	740	200	50	4	M12	190	250	3	9.0	1270	
										180M*	351.5	48	SS	470	1180	0	45	270	115	440	740	200	50	4	M12	190	250	3	9.0	1242	
										180M**	351.5	55	SS	470	1180	0	45	270	115	440	740	200	50	4	M12	190	250	4	13.9	1176	
80-250	100	80	125	470	225	280	32	67	70	180L	370.5	55	SS	470	1180	0	45	270	115	440	740	200	50	4	M12	190	250	4	13.9	1281	
										200LA	395.5	55	SS	530	1250	10	67	317	130	490	840	250	63	4	M16	205	205	4	13.9	1369	
										200L	395.5	55	SS	530	1250	10	67	317	130	490	840	250	63	4	M16	205	205	4	13.9	1349.5	
										225S	402	55	SS	530	1250	10	69	342	130	490	840	250	63	4	M16	205	205	4	13.9	1366	
										225MA	414.5	55	SS	530	1250	10	69	342	130	490	840	250	63	4	M16	205	205	4	13.9	1410	
										225M	414.5	55	SS	530	1250	10	69	342	130	490	840	250	63	4	M16	205	205	4	13.9	1463.5	
										250SA	463.5	60	SS	530	1250	10	76	370	130	490	840	250	63	4	M16	205	205	4	21.0	1481.5	
80-200	100	80	125	470	180	250	32	60	62	250M	452.5	55	SS	530	1250	10	76	370	130	490	840	250	63	4	M16	205	205	4	13.9	1527	
										160M	323	42	SS	470	1120	0	52	317	100	440	740	200	50	4	M12	190	190	3	5.4	1206	
										160L*	345	42	SS	470	1120	0	52	317	100	440	740	200	50	4	M12	190	190	3	6.7	1250	
										160L**	345	48	SS	470	1120	0	52	317	100	440	740	200	50	4	M12	190	190	3	9.0	1168.5	
										180MA	351.5	48	SS	470	1180	0	55	317	100	440	740	200	50	4	M12	190	250	3	9.0	1270	
										180M*	351.5	48	SS	470	1180	0	55	317	100	440	740	200	50	4	M12	190	250	3	9.0	1242	
										180M**	351.5	55	SS	470	1180	0	55	317	100	440	740	200	50	4	M12	190	250	4	13.9	1176	
80-250	100	80	125	470	225	280	32	67	70	180L	370.5	55	SS	470	1180	0	55	317	100	440	740	200	50	4	M12	190	250	4	13.9	1281	
										200LA	395.5	55	SS	530	1250	10	74	342	115	490	840	250	63	4	M16	205	205	4	13.9	1369	
										200L	395.5	55	SS	530	1250	10	74	342	115	490	840	250	63	4	M16	205	205	4	13.9	1349.5	
										225S	402	55	SS	530	1250	10	65	342	115	490	840	250	63	4	M16	205	205	4	13.9	1366	
										225MA	414.5	55	SS	530	1250	10	65	342	115	490	840	250	63	4	M16	205	205	4	13.9	1410	
										225M	414.5	55	SS	530	1250	10	65	342	115	490	840	250	63	4	M16	205	205	4	13.9	1463.5	
										250SA	463.5	60	SS	530	1250	10	74	370	115	490	840	250	63	4	M16	205	205	4	21.0	1481.5	
80-200	100	80	125	470	180	250	32	60	62	250M	452.5	55	SS	530	1250	10	74	370	115	490	840	250	63	4	M16	205	205	4	13.9	1527	
										160M	323	42	SS	470	1120	0	52	317	100	440	740	200	50	4	M12	190	190	3	5.4	1206	
										160L*	345	42	SS	470	1120	0	52	317	100	440	740	200	50	4	M12	190	190	3	6.7	1250	
										160L**	345	48	SS	470	1120	0	52	317	100	440	740	200	50	4	M12	190	190	3	9.0	1168.5	
										180MA	351.5	48	SS	470	1180	0	55	317	100	440	740	200	50	4	M12	190	250	3	9.0	1270	
										180M*	351.5	48	SS	470	1180	0	55	317	100	440	740	200	50	4	M12	190	250	3	9.0	1242	
										180M**	351.5	55	SS	470	1180	0	55	317	100	440	740	200	50	4	M12	190	250	4	13.9	1176	

Dimension Table for 2P Motor Drive

Pump Sizes	Pump							Motor			Base Plate				Foundation Dimensions								Coupling		Refer.						
	Bore		Dimension				Axle	Weight		Frame	Dimension		Material	b3	I3	A	Wt.	h3	i	b2	I2	M	N	P		Q	V1	V2	t	Wt.	TL
	DN1	DN2	a	f	h1	h2	d1	Grade	Grade		R	d2																			
	mm	mm	mm	mm	mm	mm	mm	kg	kg	mm	mm	mm	mm	mm	mm	mm	mm	mm	mm	mm	mm	mm	mm	mm		mm	mm	mm	mm	mm	
32-200 40-200 50-160	50 65 80	32 40 50	80 80 100	360 360 360	160 1																										

Motor Parameter Comparison Table by Motor Type

2P Motor

Frame size	Center height	Shaft dia.	Totally enclosed fan-cooled (TU motor)		Drip-proof		Increased-safety explosion-proof		Flame-proof	
	R		d2	Output	Weight	Output	Weight	Output	Weight	Output
---	mm	mm	kW	kg	kW	kg	kW	kg	kW	kg
71M	120	14	0.4	7	-	-	0.4	7.2	0.4	17
80	140	19	-	-	-	-	-	-	-	-
80M	140	19	0.75	18	0.75	9	0.75	11.5	0.75	26
90S	156	24	-	-	-	-	-	-	-	-
90L	168.5	24	1.5	27.5	1.5	15.5	1.5	18.5	1.5	29
100L	193	28	2.2	28	2.2	16	2.2	29.5	-	42
112M	200	28	3.7	47	3.7	27	3.7	40	3.7	58
132S	239	38	5.5	73	5.5	34	5.5	60	5.5	74
160M	323	42	11	133	11	65	7.5	85	11	125
160L*	345	42	15	135	15	75	-	-	15	15
160L**	345	48	-	-	22	105	-	-	-	-
180M*	351.5	48	22	235	-	-	15	150	22	205
180MA	351.5	48	-	-	-	-	-	-	-	-
180M**	351.5	55	-	-	30	120	-	-	-	-
180L	370.5	55	30	248	37	190	-	-	-	-
200LA	395.5	55	-	-	-	-	-	-	-	-
200L	395.5	55	37	333	45	357	-	-	22	240
225S	402	55	55	467	-	-	30	310	37	390
225MA	414.5	55	-	-	-	-	-	-	-	-
225M	414.5	55	-	-	-	-	-	-	45	450
250SA	463.5	60	-	-	-	-	-	-	-	-
250M	462.5	55	-	-	-	-	45	550	55	590

4P Motor

Frame size	Center height	Shaft dia.	Totally enclosed fan-cooled (TU motor)		Drip-proof		Increased-safety explosion-proof		Flame-proof	
	R		d2	Output	Weight	Output	Weight	Output	Weight	Output
---	mm	mm	kW	kg	kW	kg	kW	kg	kW	kg
71M	120	14	0.4	8	-	-	0.4	9	0.4	17
80	140	19	-	-	-	-	-	-	-	-
80M	140	19	0.75	11	0.75	10.5	0.75	12	0.75	28
90L	168.5	24	1.5	20	1.5	16	1.5	20	1.5	30
100L	193	28	2.2	25	2.2	22	2.2	33	2.2	45
112M	200	28	3.7	37	3.7	30	3.7	41	3.7	58
132S	239	38	5.5	49	5.5	40	5.5	60	5.5	77
132M	258	38	7.5	60	7.5	51	7.5	74	7.5	95
160M	323	42	11	85	11	70	11	98	11	115
160L*	345	42	15	105	15	85	15	115	15	145
160L**	345	48	-	-	18.5	110	-	-	-	-
180MC	351.5	48	-	-	-	-	-	-	-	-
180M*	351.5	48	18.5	130	-	-	18.5	165	18.5	200
180M**	351.5	55	-	-	22	125	-	-	-	-
180LC	370.5	48	-	-	-	-	-	-	-	-
180L*	370.5	55	30	175	-	-	-	-	-	-
200LC	395.5	55	-	-	-	-	-	-	-	-
200L*	395.5	55	-	-	-	-	-	-	30	375
200L**	425.5	60	37	230	-	-	22	230	-	-
180L**	400.5	60	-	-	37	195	-	-	-	-
225SC	432	60	-	-	-	-	-	-	-	-
225S*	432	60	-	-	-	-	-	-	37	440
225S**	432	65	55	275	-	-	30	295	-	-
200M	406.5	65	-	-	55	240	-	-	-	-
225MC	444.5	60	-	-	-	-	-	-	-	-
225M	444.5	60	-	-	-	-	-	-	45	500
250SC	463.5	70	-	-	-	-	-	-	-	-
250M*	482.5	65	-	-	-	-	-	-	55	600
250M**	482.5	75	90	520	-	-	45	550	-	-
225S	432	75	-	-	75	350	-	-	-	-
225M	444.5	75	-	-	90	380	-	-	-	-
250S	463.5	75	75	470	-	-	-	-	-	-
250MC	482.5	70	-	-	-	-	-	-	-	-
280SB	544	80	-	-	-	-	-	-	-	-
280S*	514	75	-	-	-	-	-	-	75	780
280M*	539.5	75	-	-	-	-	-	-	90	920
280M**	569.5	85	132	800	-	-	75	800	-	-
250S	493.5	85	-	-	110	500	-	-	-	-
250M***	512.5	85	-	-	132	565	-	-	-	-
280S**	544	85	110	685	-	-	-	-	-	-
280MB	569.5	80	-	-	-	-	-	-	-	-
315SB	589	85	-	-	-	-	-	-	-	-

6P Motor

Frame size	Center height	Shaft dia.	Totally enclosed fan-cooled (TU motor)		Drip-proof		Increased-safety explosion-proof		Flame-proof	
	R		d2	Output	Weight	Output	Weight	Output	Weight	Output
---	mm	mm	kW	kg	kW	kg	kW	kg	kW	kg
100L	193	28	1.5	38	-	-	-	-	-	-
112M	200	28	2.2	46	-	-	-	-	-	-
132S	239	38	3.7	68	-	-	-	-	-	-
132M	258	38	5.5	79	-	-	-	-	-	-
160M	323	42	7.5	125	-	-	-	-	-	-
160L	345	42	11	140	-	-	-	-	-	-
180M	351.5	48	15	250	-	-	-	-	-	-
180L	370.5	55	18.5	225	-	-	-	-	-	-
200L	425.5	60	30	385	-	-	-	-	-	-
225S	432	65	45	500	-	-	-	-	-	-
250S	463.5	75	55	565	-	-	-	-	-	-
250M	482.5	75	75	640	-	-	-	-	-	-
280S	544	85	90	750	-	-	-	-	-	-
280M	569.5	85	110	725	-	-	-	-	-	-

Note: Totally enclosed fan-cooled motor is only available for TU motor, Torishima Ultra motor.

Potential Energy Saving with the Eco-Pump

The Eco-Pumps reduce power consumption by 10~30%!

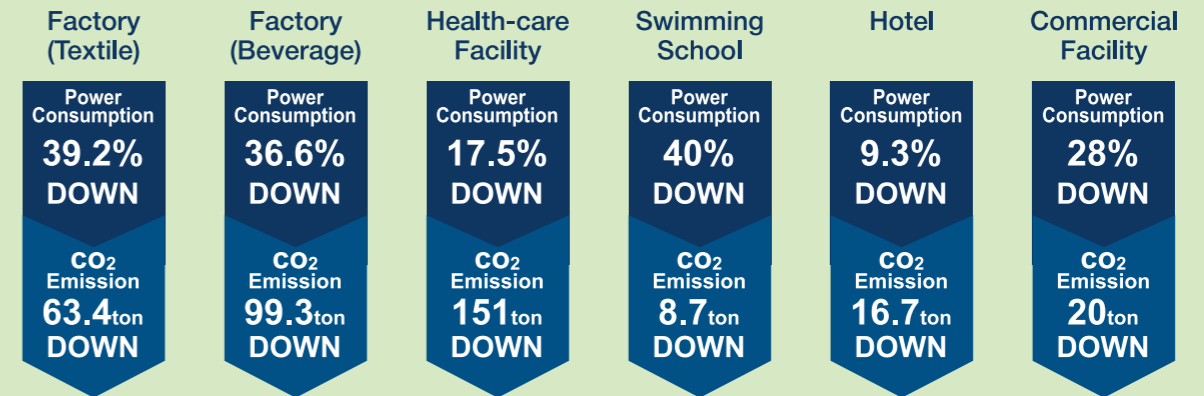

The above figures are a few examples of successful installation of the Eco-Pumps in various industries.

6 typical examples where big energy savings can be expected:

- Pump flow rate controlled by valve
- Pump operating at fixed speed
- Pump with high annual operating hours
- Pump with oversized motor
- Old pump
- Pump for new facility

We propose several solutions depending on your situation:

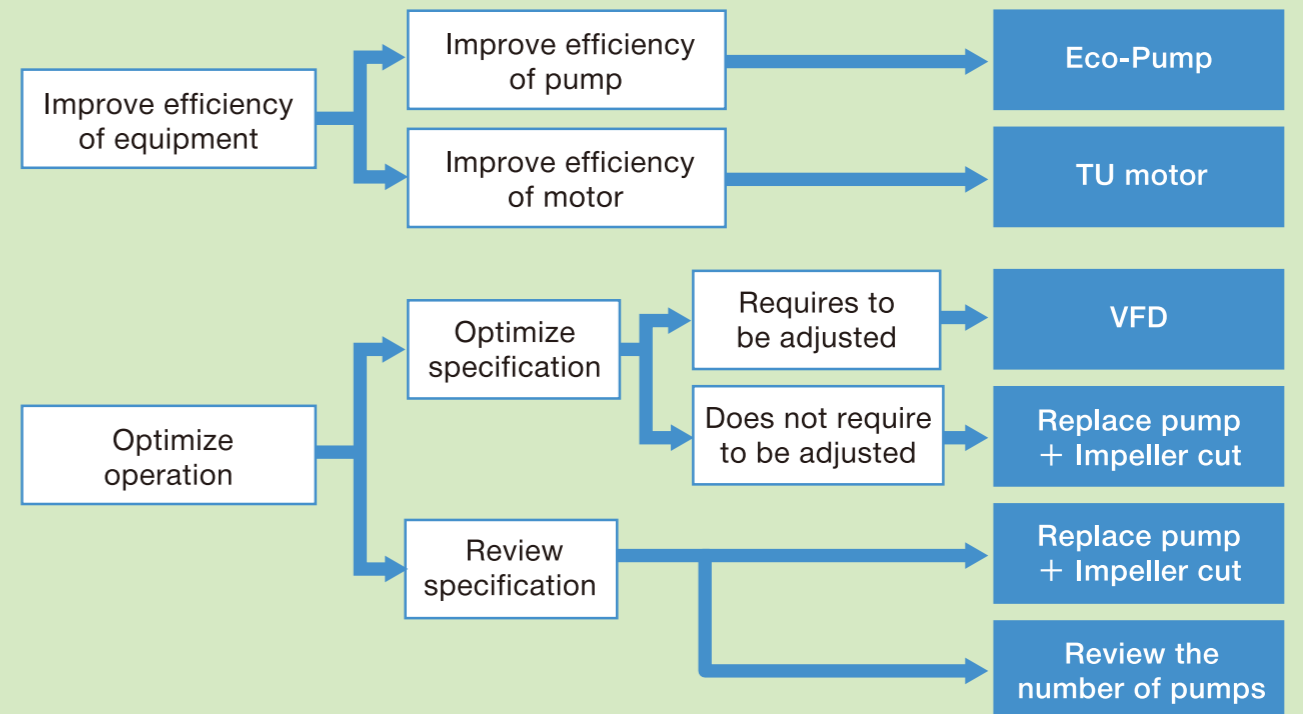

Would you like to try to select an Eco-Pump that meets your requirements, look at testimonials, or just learn more about the Eco-Pumps?
Then please visit the Eco-Pump website:
www.torishima.co.jp/en/ecopump/index.html

